

Rental Res: 30-d min.
 Pets: small

Built: 82-83
 St: 15
 Un: 94

AMENITIES:
 Heated pool
 Jacuzzi
 Sauna
 Tennis (2)
 Exercise rm (Sand I)
 Rec room
 BBQ
 Washer/dryer in uni
 Assigned, covered
 parking

No.	Sq.Ft.	Bed	Bath
01	1326	2	2
02	1020	2	2
03	962	2	2
04	863	1	1½
05	1148	2	2
06	1318	2	2

↑ BEACH ↑

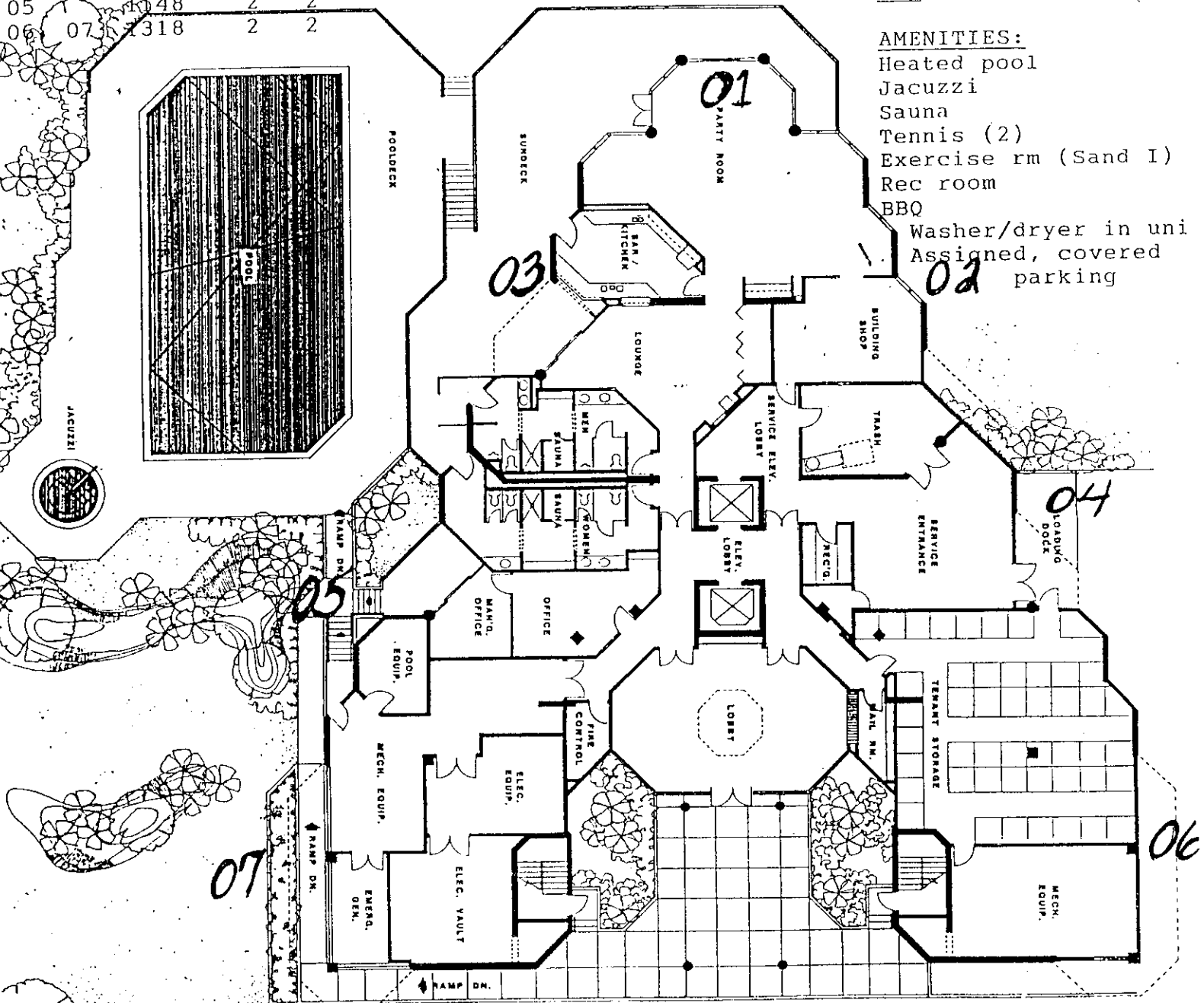

LOWER LEVEL PLAN

Sandcastle I
 (SOUTH)

I = 730 So. Collier
 II = 720 So. Collier

No.	Sq.Ft.	Bed	Bath
01	1326	2	2
02	1020	2	2
03	962	2	2
04	863	1	1½
05	1148	2	2
06	1318	2	2

Rental Res: 30-d min.
 Pets: small

Built: 82-83
 St: 15
 Un: 94

AMENITIES:
 Heated pool
 Jacuzzi
 Sauna
 Tennis (2)
 Exercise rm (Sand I)
 Rec room
 BBQ
 Washer/dryer in unit
 Assigned, covered parking

↑ BEACH ↑

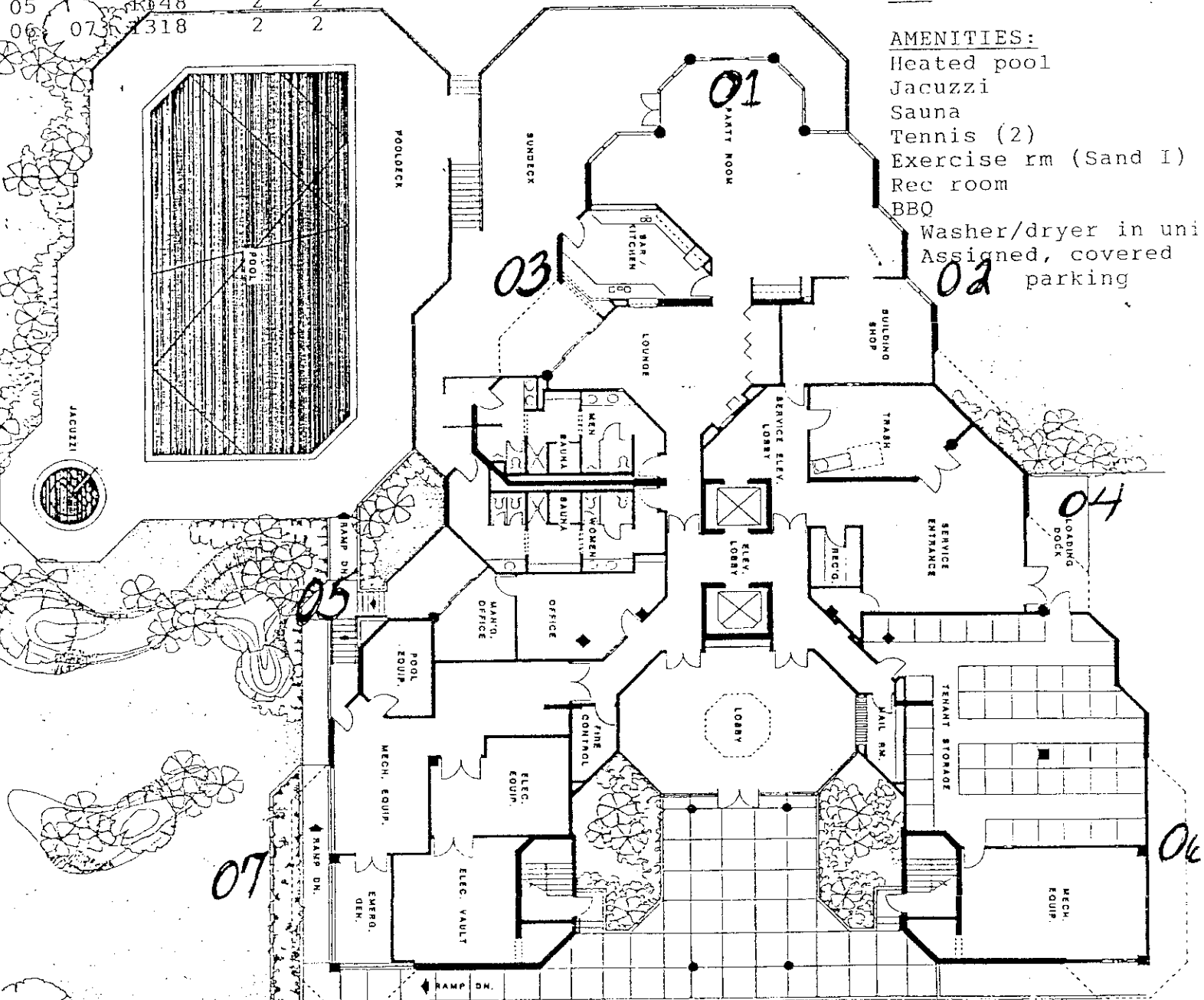

LOWER LEVEL PLAN

Sandcastle II
 (NORTH)

I= 730 So. Collier
 II= 720 So. Collier

GULF"
OF MEXICO

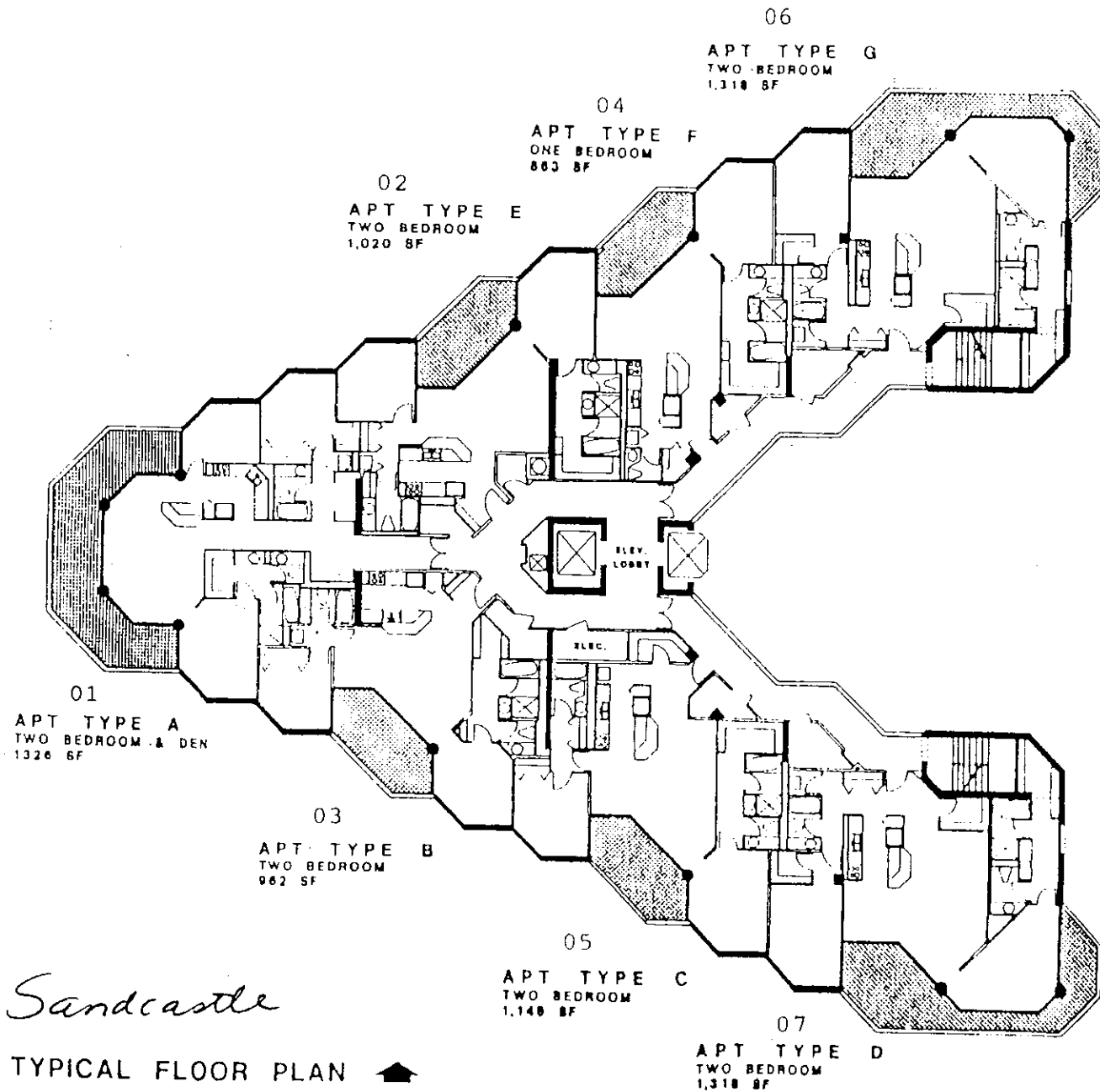

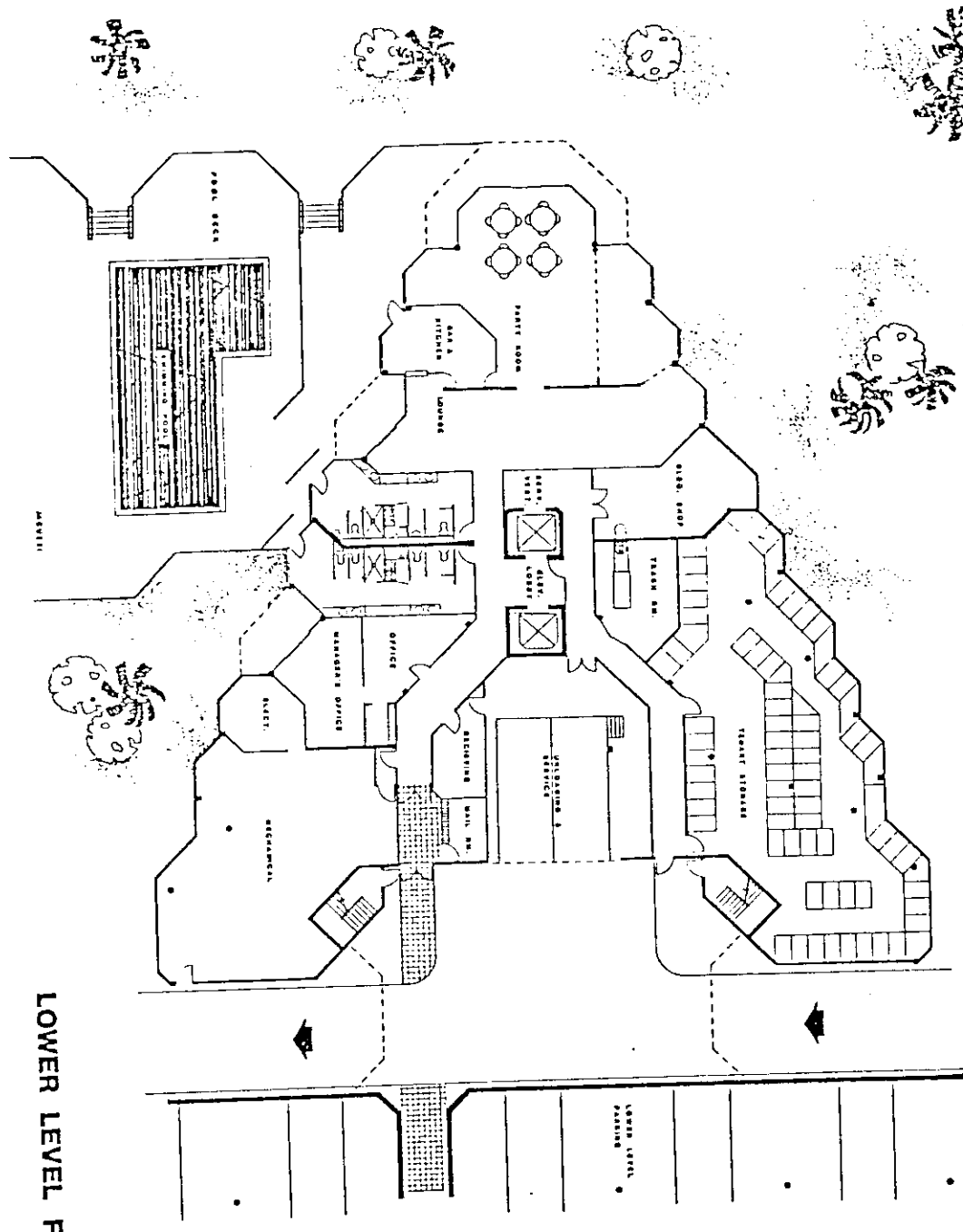

LOWER LEVEL FLOOR PLAN

SCHIFFORDING
ARCHITECTS
& ENGINEERS
P.C.
BRANSON

THE SAND CASTLE MARCO ISLAND, FLORIDA

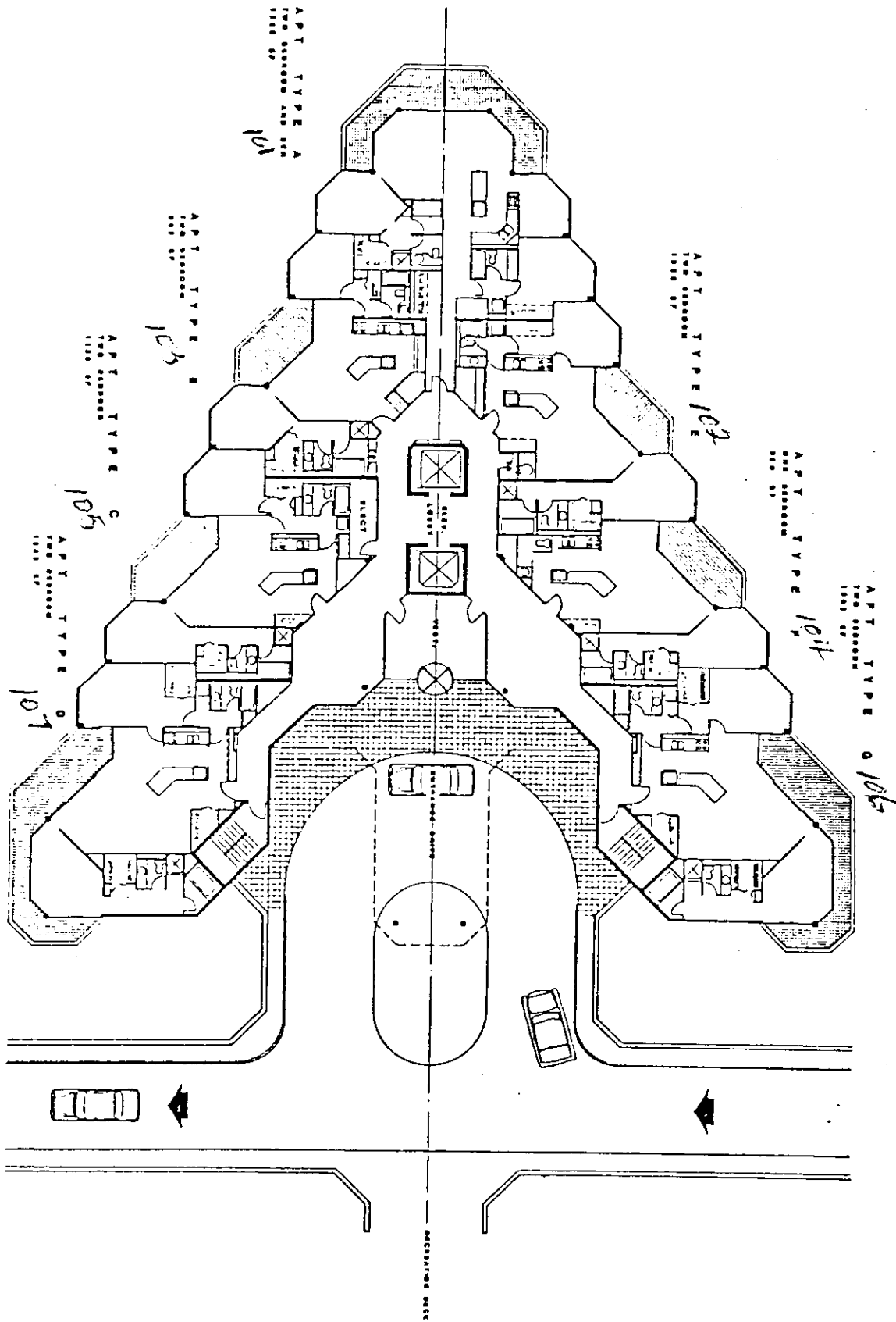

**THE SAND CASTLE
MARCO ISLAND, FLORIDA**

SUPPORTING ARCHITECTS PLANNERS

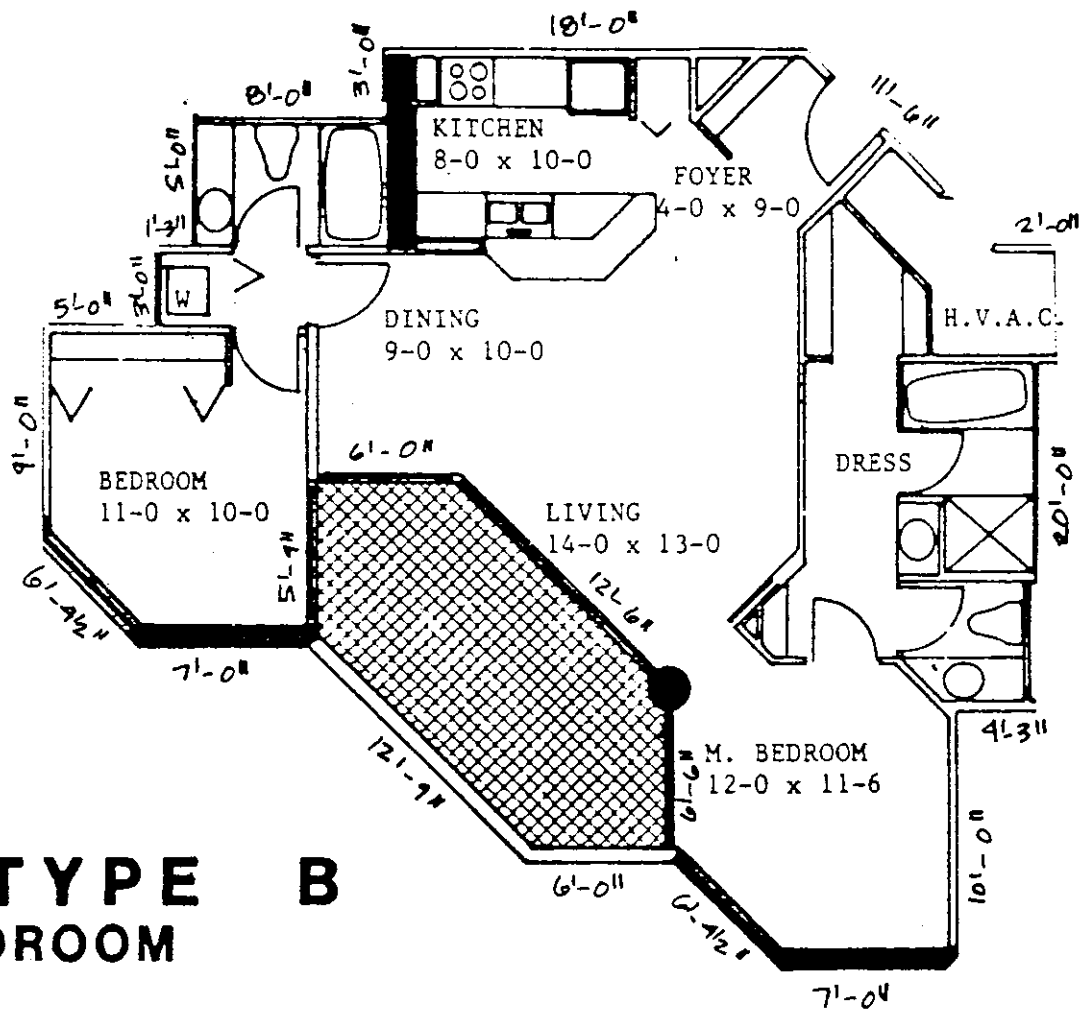

APT TYPE B
TWO BEDROOM
962 SF

All dimensions are approximate

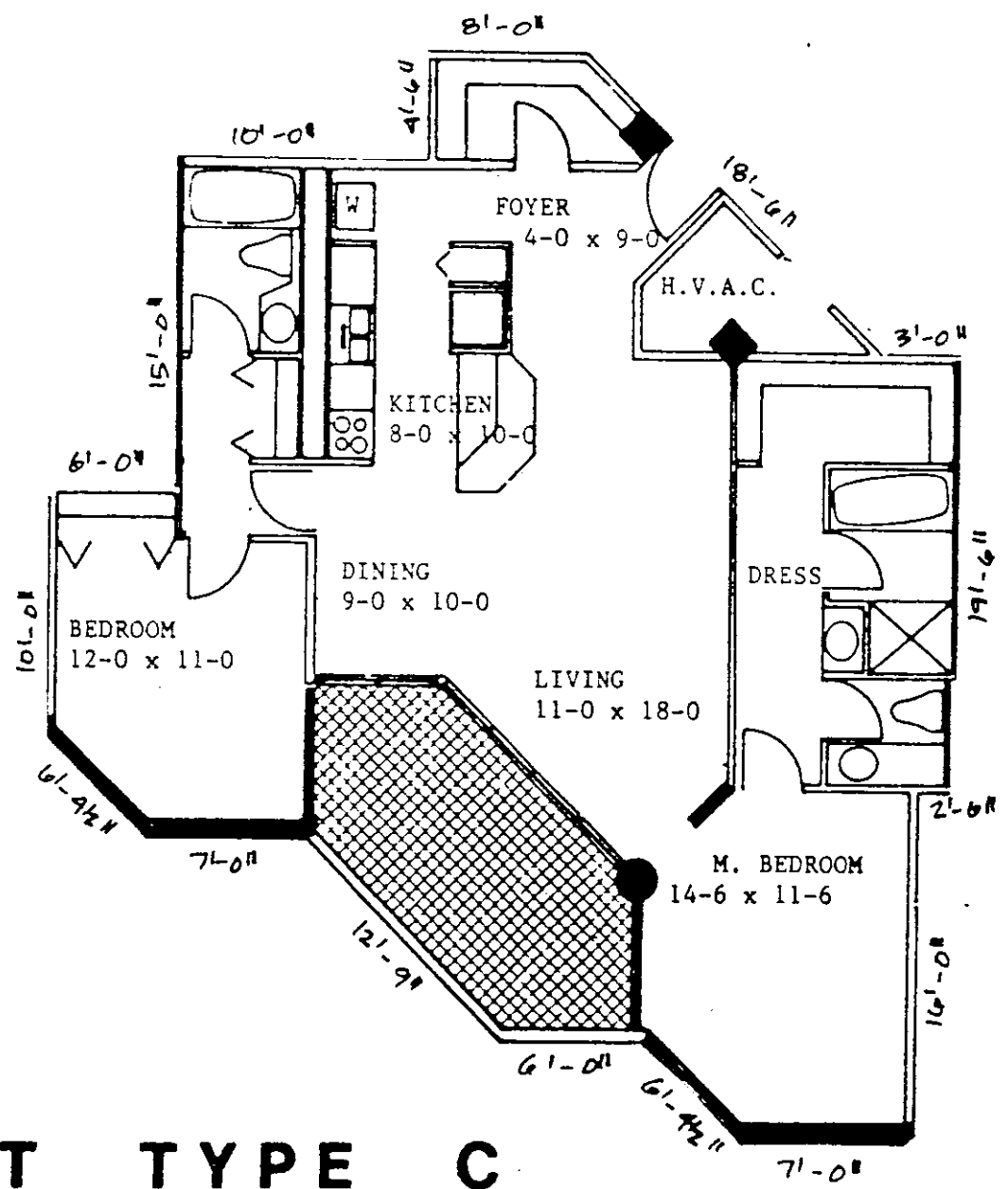

APT TYPE C
TWO BEDROOM
1,148 SF

All dimensions are approximate

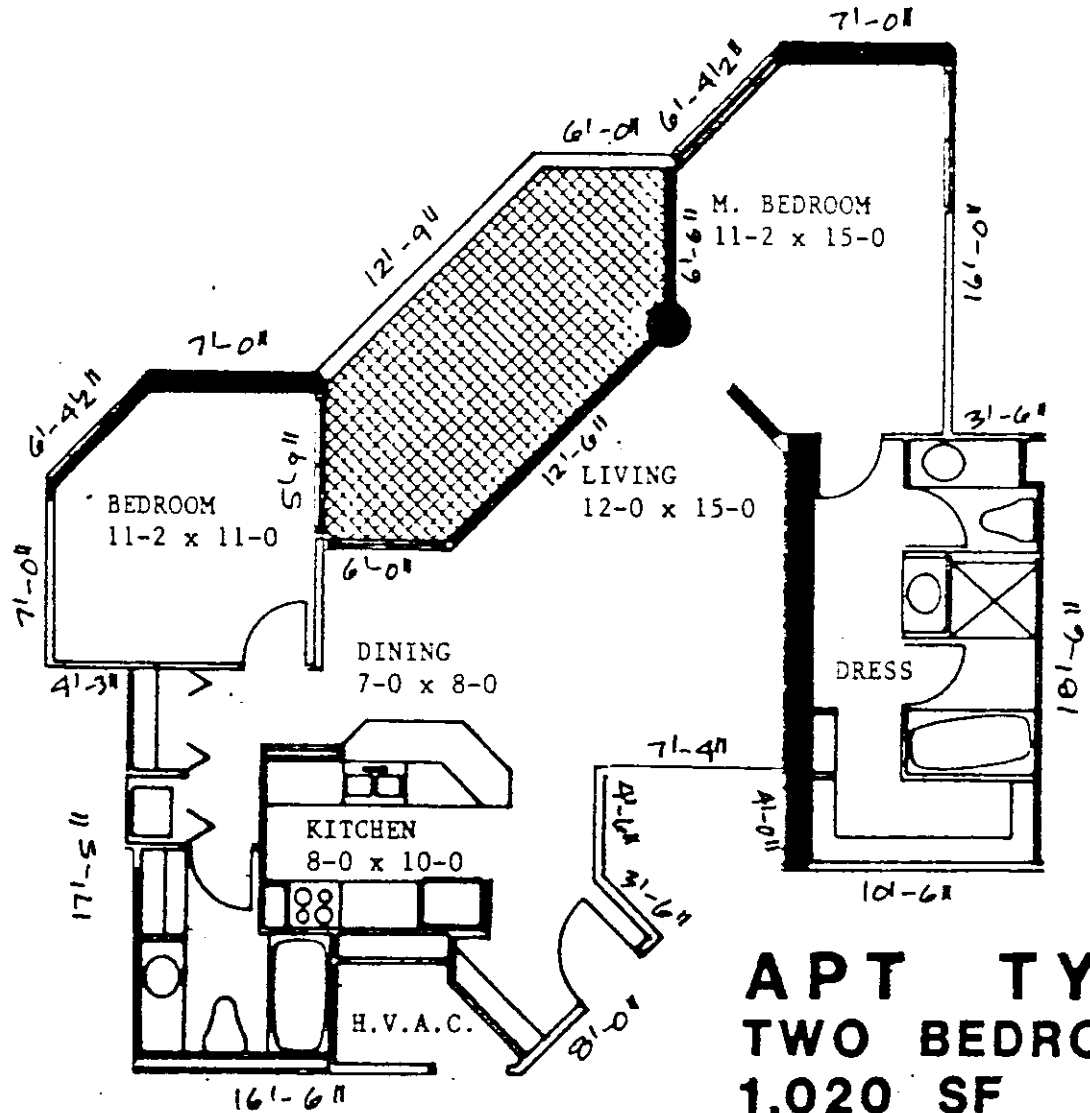

APT TYPE E
TWO BEDROOM
1,020 SF

All dimensions are approximate

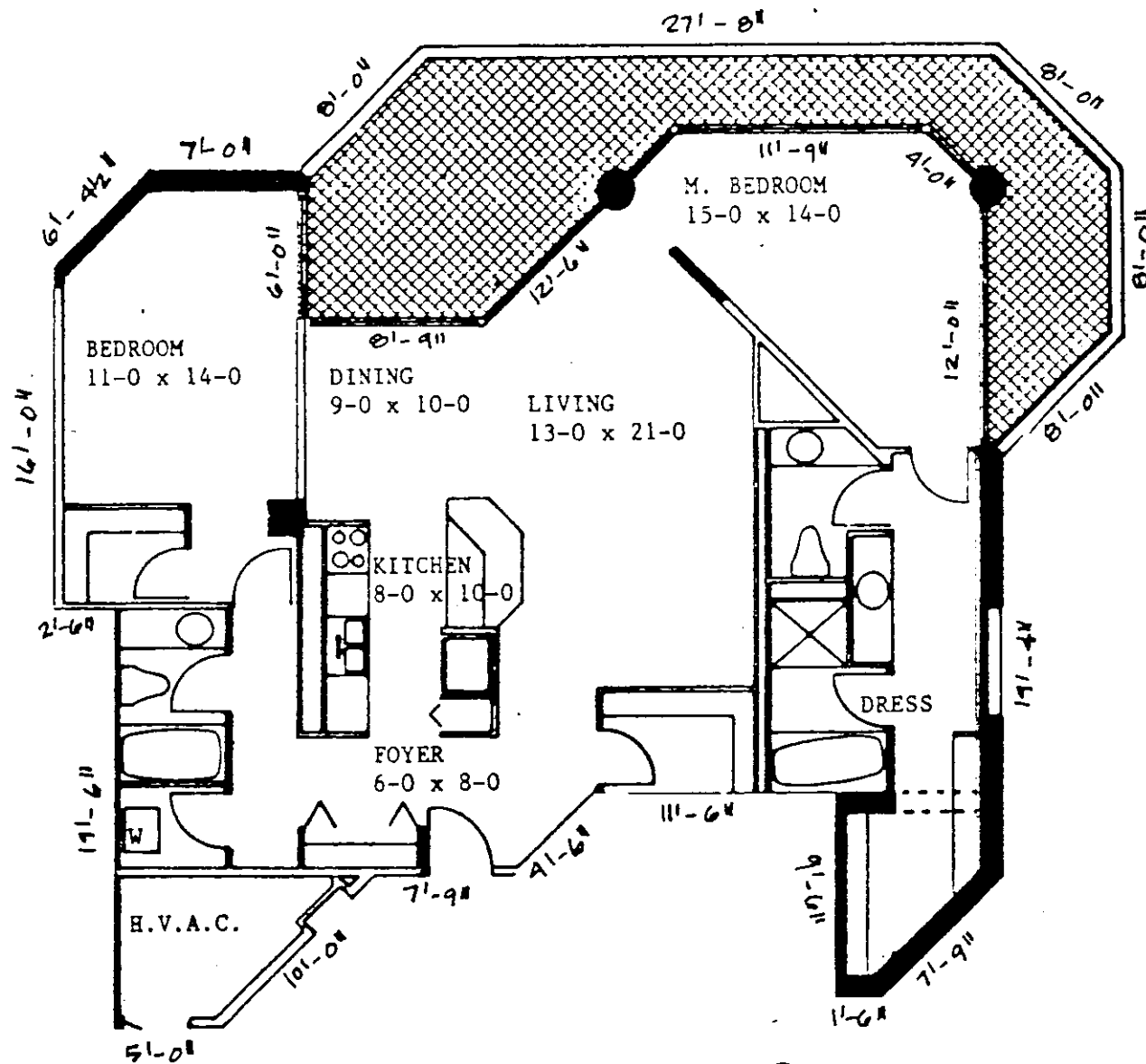

APT TYPE G
TWO BEDROOM
1,318 SF

All dimensions are approximate

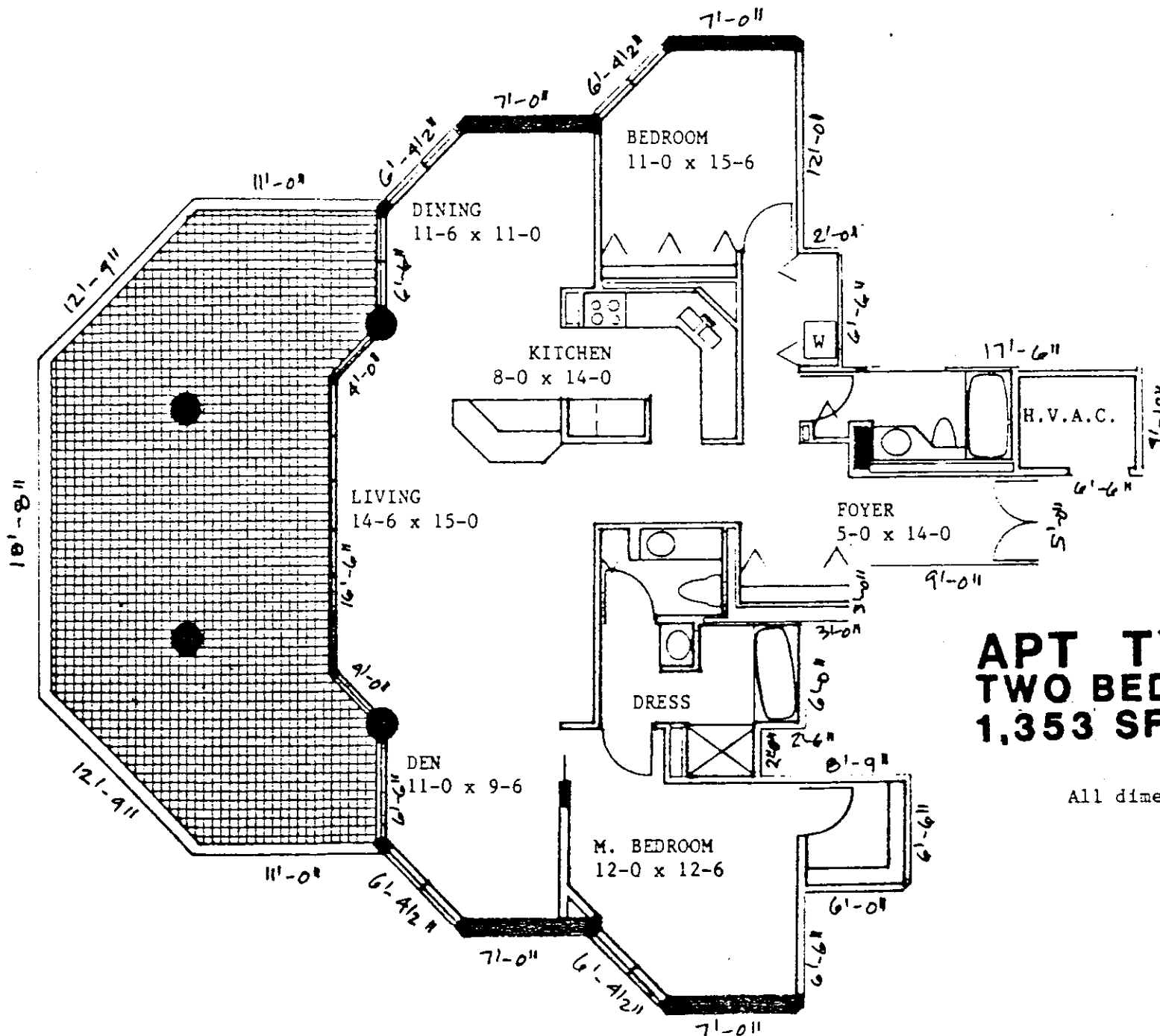

APT TYPE K

TWO BEDROOM & DEN

1,353 SF

All dimensions are approximate

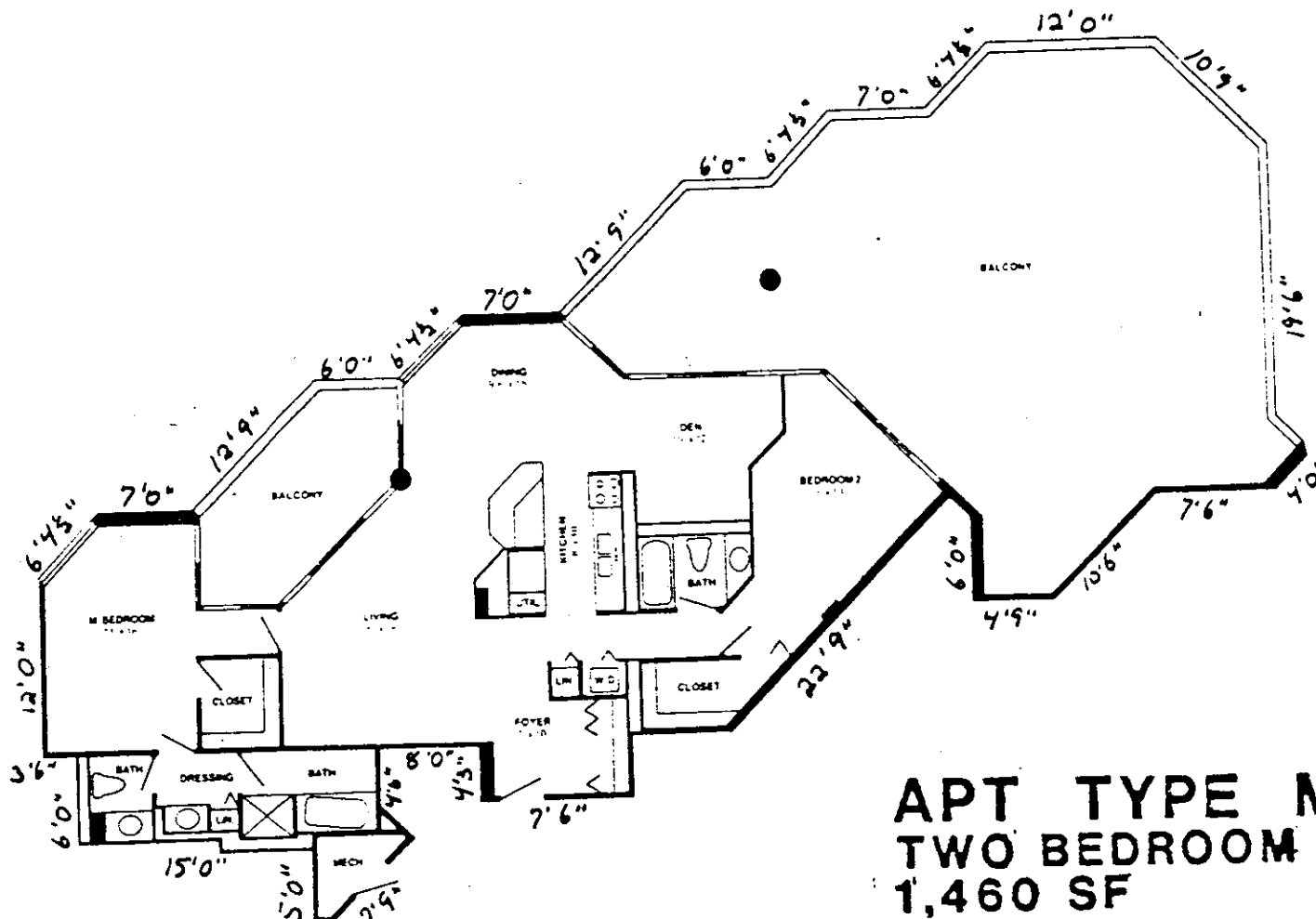

**APT TYPE M
TWO BEDROOM & DEN
1,460 SF**

All dimensions are approximate
(Revised Apt Type M)

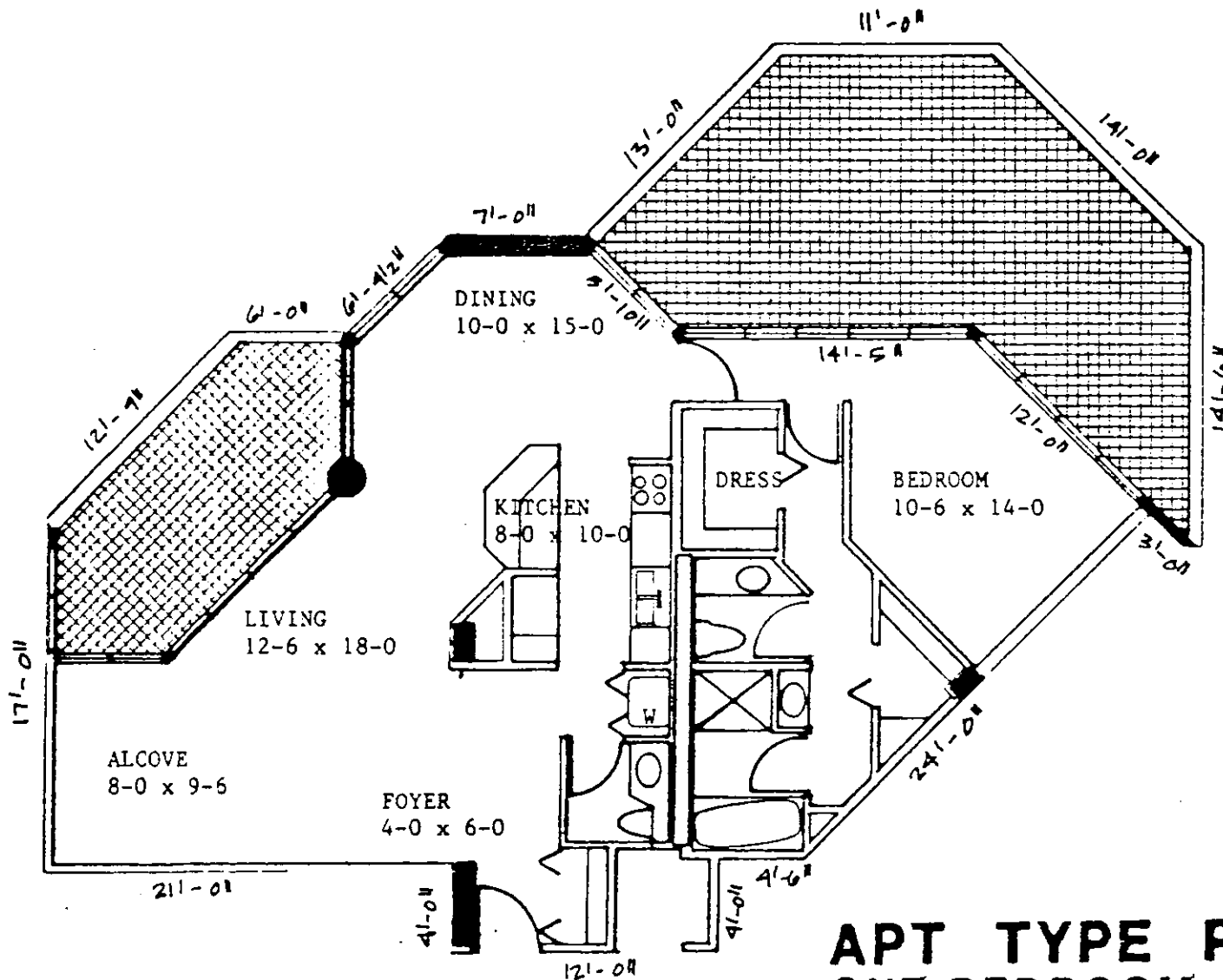

APT TYPE P
ONE BEDROOM & ALCOVE
1,081 SF

All dimensions are approximate

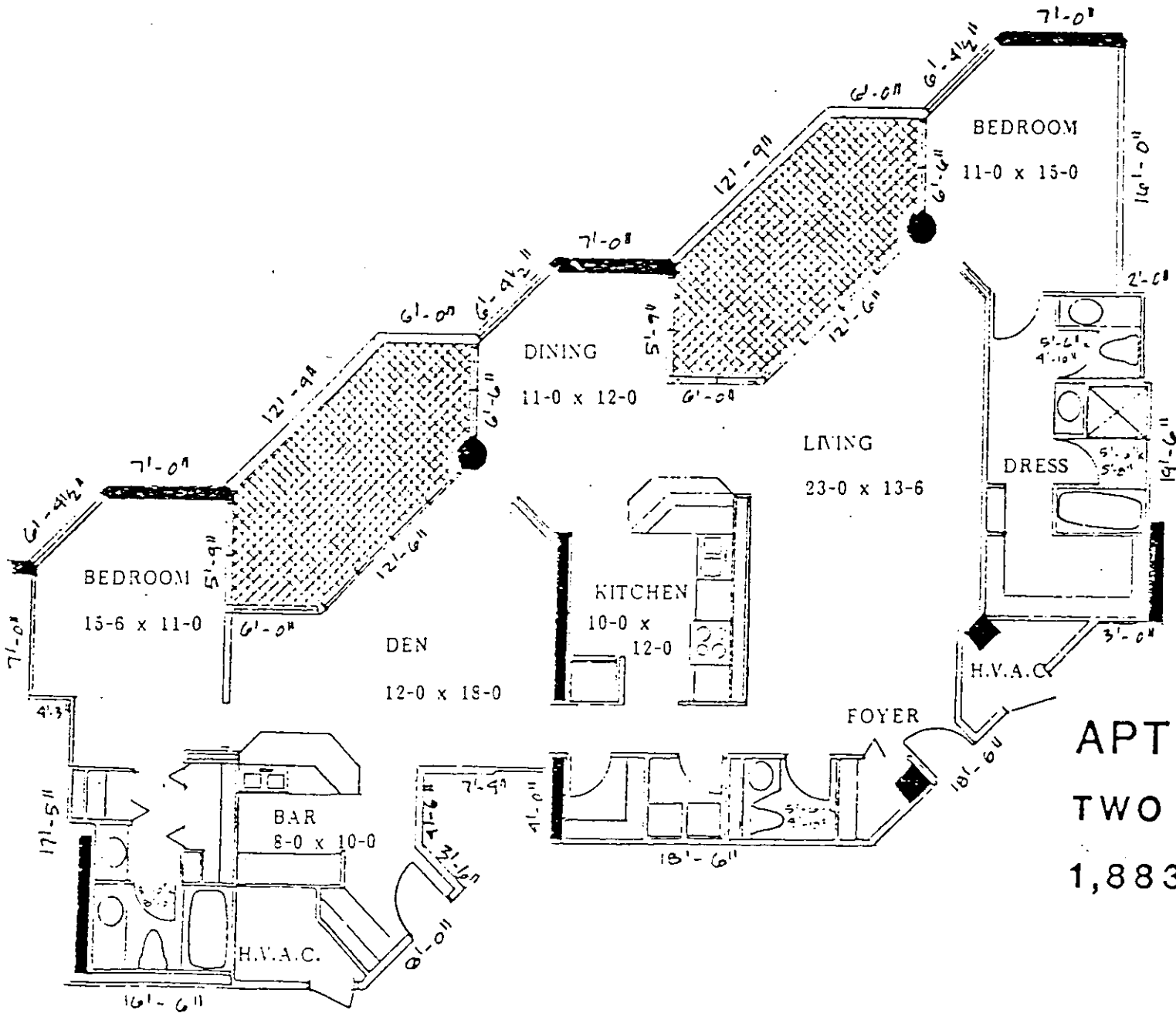

APT TYPE Q
TWO BEDROOM & DEN
1,883 SF